

Mesa Due Meeting Table — L. and M. Vignelli — 2016



Il concetto di tavolo nella sua essenzialità scultorea. Mesa. Progetto di Lella & Massimo Vignelli nato nel 1985. Una matrice fertile di sviluppi, da cui Poltrona Frau trae una collezione sempre più ampia e trasversale. Mesa Due Meeting Table è la nuova versione per gli spazi di lavoro. Sostanziosa nei materiali, tecnologica nelle prestazioni, flessibile nel design.

The concept of the table in its sculptural essentiality. Mesa is a project by Lella & Massimo Vignelli from 1985. This fertile matrix of developments has been drawn on by Poltrona Frau to create a continually expanding and transversal collection. Mesa Due Meeting Table is the new version for workspaces. It combines sophisticated materials, technological performance and flexible design.

CARATTERISTICHE TECNICHE

Modelli e dimensioni.

- Round Meeting Table ø120
- Round Meeting Table ø150
- Rectangular/Oval Meeting Table
 - 296×150
 - 369×150
 - 442×150
 - 515×150
 - 588×150
 - 661×150
 - 734×150

ROUND MEETING TABLE

Struttura portante. Colonna in acciaio stabilizzata internamente da un sistema di contrappesi. Alla base è posto un puntale sagomato in materiale plastico a protezione del pavimento.

Basamento a colonna. Disponibile in:

- cuoio Saddle Extra con cuciture a contrasto
- Pelle Frau® Color System con cuciture tono su tono

Raccordo piano - colonna. Tubolare in acciaio verniciato nero su cui poggia una crociera a tre bracci con supporti regolabili per il livellamento del piano. Le parti metalliche non a vista sono verniciate di colore nero.

Piano. In MDF con doppia pannellatura a bordo smussato: il pannello inferiore è verniciato nero testurizzato mentre quello superiore può essere rivestito in pelle o impiallacciato in tranciato di frassino.

Finitura piano. Disponibile in

- Frassino tinto wengé (32)
- Frassino tinto moka (61)
- Pelle Frau® Color System

Quando il rivestimento è in pelle, la colonna è in Pelle Frau® Color System in abbinamento.

Predisposizione. Su richiesta è possibile attrezzare la parte centrale del piano con l'inserimento di una torretta elettrificata a scomparsa, scelta e specificata dal cliente in fase di acquisto. Il dispositivo di elettrificazione deve essere acquistato ed installato dal cliente successivamente alla consegna. Per assicurare una corretta predisposizione in fase produttiva si raccomanda l'invio di un campione.

TECHNICAL FEATURES

Versions and sizes.

- Round Meeting Table ø120
- Round Meeting Table ø150
- Rectangular/Oval Meeting Table
 - 296×150
 - 369×150
 - 442×150
 - 515×150
 - 588×150
 - 661×150
 - 734×150

ROUND MEETING TABLE

Supporting structure. Made of steel and a series of counterweights allows the table to remain stable. A shaped plastic cap is attached to the base of the column to protect the floor.

Column base. Available in:

- Saddle Extra leather with contrast stitching
- Pelle Frau® Color System leather with tone-on-tone stitching

Top - column junction. Tubular steel structure in a dark brown stain assembled with three adjustable brackets which allow to level the top. The non-visible metal parts are finished with a black stain.

Top. MDF with double panelling and rounded edges: the bottom panel is coated with textured black paint while the top panel can be upholstered in leather or in ash wood veneer.

Top finishing. Available in

- Ash in a wengé stain (32)
- Ash in a moka stain (61)
- Pelle Frau® Color System

When upholstered in leather, the column is in combination and upholstered in Pelle Frau® Color System.

Arrangement. Upon request, it is possible to arrange the central part of the table top with a disappearing electrical outlet, chosen and specified by the customer at the time the order is placed. The electrical device must be purchased and installed by the client following delivery. To ensure proper placement during the production process, customers are strongly encouraged to submit a sample.

RECTANGULAR/OVAL MEETING TABLE

Struttura portante. Colonna in acciaio stabilizzata internamente da un sistema di contrappesi. Alla base è posto un puntale sagomato in materiale plastico a protezione del pavimento.

Basamento a colonna. In Pelle Frau® Color System con cuciture tono su tono.

Telaio. Struttura di supporto al piano in ferro verniciato nero.

Piano. In MDF con doppia pannellatura a bordo smussato: il pannello inferiore è verniciato nero testurizzato mentre quello superiore è rivestito in pelle.

Rivestimento piano. In Pelle Frau® Color System (SC).

Versionsi.

- Senza pannelli centrali
- Con pannelli centrali
- Hardware con pannelli centrali e passacavi
- Hardware con sportelli

Con pannelli centrali. È dotata di un tunnel passacavi in lamiera di metallo traforata e verniciata di colore nero. Al di sopra del tunnel passacavi si estende una fila di pannelli in MDF rivestiti in pelle.

Hardware con pannelli centrali e passacavi. Presenta, in aggiunta alla versione precedente, una serie di borchie in metallo inserite al centro di ciascun pannello centrale che consentono l'uscita dei cavi sul piano e disponibili nella versione:

- Cromata
- Verniciata nera

Hardware con sportelli. È attrezzata, nella parte centrale del piano, al di sopra del tunnel passacavi, con una serie di sportelli rivestiti in pelle. Ogni sportello dà accesso a un vano interno dotato di una borchia passacavi in metallo disponibile nella versione:

- Cromata
- Verniciata nera

Su richiesta, è possibile personalizzare i vani interni con un dispositivo di elettrificazione fornito dal cliente e da acquistare separatamente.

Predisposizione passaggio cavi. Fornita e personalizzata in base ai dispositivi di elettrificazione scelti e specificati dal cliente in fase di acquisto. Tali dispositivi devono essere acquistati ed installati dal cliente successivamente alla consegna. Per assicurare una corretta predisposizione in fase produttiva si raccomanda l'invio di un campione.

Optional (solo per Meeting Table rettangolari).

- Con "President area"
- Senza "President area"

"President area". È prevista, a scelta, in uno dei due lati corti dei Meeting Table rettangolari. È rivestita in pelle in abbinamento al piano o di colore differente.

RECTANGULAR/OVAL MEETING TABLES

Supporting structure. Made of steel and a series of counterweights allows the table to remain stable. A shaped plastic cap is attached to the base of the column to protect the floor.

Column base. In Pelle Frau® Color System leather with tone-on-tone stitching.

Frame. Top supporting structure in iron with a black stain.

Top. Rounded-edge double panelling made of MDF: the bottom panel has a black textured finish while the top is covered in leather.

Top covering. In Pelle Frau® Color System (SC) leather.

Versions.

- Without central panels
- With central panels
- Hardware with central panels and cable management
- Hardware with doors

With central panels. It features a cable management tunnel in black perforated sheet steel. The row of MDF panels above the cable tunnel are leather-covered.

Hardware with central panels and cable management. It features the same tunnel as the version above plus a series of metal grommets, which allows the cables to come out, located in the middle of each central panel and available in a:

- Chrome finishing
- Black stained finishing

Hardware with doors. It features, in the central part of the tabletop, above the cable passageway, a series of doors covered in leather. Each door gives access to an internal compartment equipped with a metal cable grommet available in a:

- Chrome finishing
- Black stained finishing

Upon request, it is possible to personalise the internal compartments with an electrical device supplied by the customer and purchased separately.

Predisposition for the cable management system. It is supplied and personalised based on the electrical devices chosen and specified by the customer at the time the order is placed. These devices must be purchased and installed by the client following delivery. To ensure proper placement during the production process, customers are strongly encouraged to submit a sample.

Accessories (only for rectangular Meeting Tables).

- With President area
- Without President area

President area. If provided, it can be placed on one of the two shorter sides of the rectangular Meeting Tables. It is covered in leather, matching the top or in a different colour.

RECTANGULAR / OVAL MEETING TABLE

I PIANI SONO DISPONIBILI IN 4 VERSIONI: STANDARD, CON PANNELLI CENTRALI, E 2 VERSIONI HARDWARE, DIVERSAMENTE CONFIGURABILI PER IL PASSAGGIO CAVI.

TABLES AVAILABLE IN 4 VERSIONS: STANDARD, WITH CENTRAL PANELS, AND 2 HARDWARE, THAT CAN BE CONFIGURABLE WITH THE CABLE MANagements.

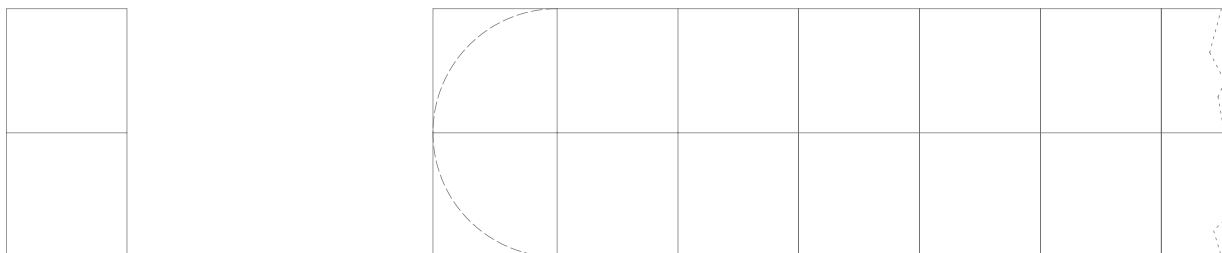
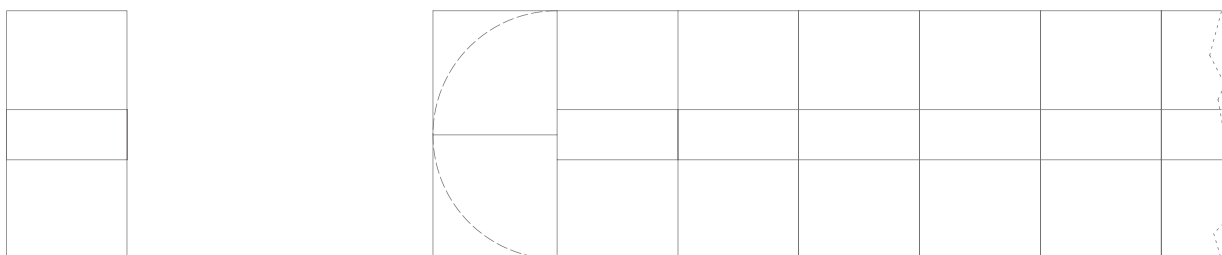
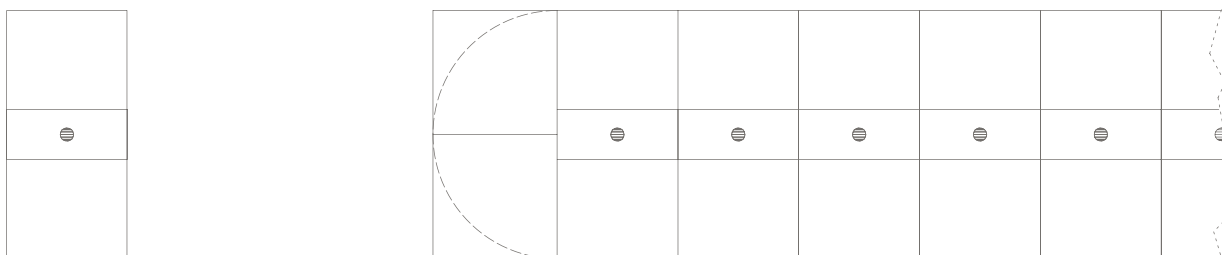
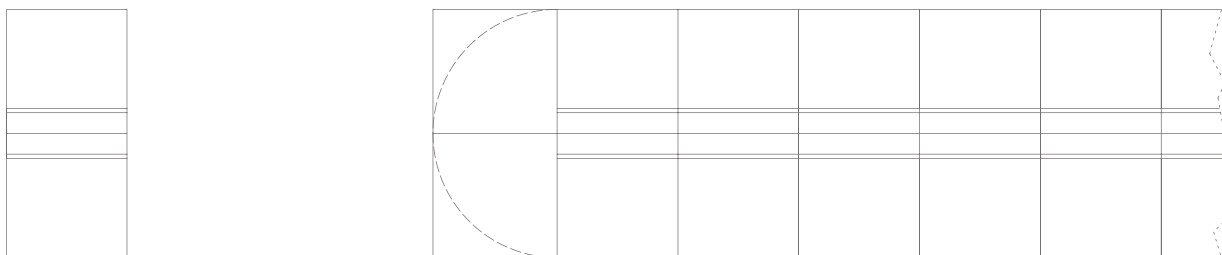
VERSIONE STANDARD (SENZA PANNELLI CENTRALI) / STANDARD VERSION (WITHOUT CENTRAL PANELS)

CON PANNELLI CENTRALI (*) / WITH CENTRAL PANELS (*)

HARDWARE CON PANNELLI CENTRALI E BORCHIE PASSACAVI / HARDWARE WITH FIXED CENTRAL PANELS AND CABLE GROMMETS

HARDWARE CON SPORTELLI CENTRALI / HARDWARE WITH CENTRAL DOORS

(*) La struttura, le gambe e il telaio del tavolo sono predisposti per il passaggio cavi. Su richiesta, i pannelli centrali del piano possono essere equipaggiati con accessori elettrici forniti dal cliente e approntati da Poltrona Frau.

N.B. Le quotazioni e i tempi di consegna variano a seconda della personalizzazione richiesta e saranno comunicati di volta in volta. Poltrona Frau può approntare i tavoli per accogliere accessori elettrici ma non può fornire il prodotto cablato.

(*) Structure, legs and frame of the table are suited for the cable management. On request, the central panels can be equipped with power sockets supplied by the client and set up by Poltrona Frau.

Please Note. Prices and delivery terms may vary depending on the customization requested that will be communicated individually. Poltrona Frau can set up the tables for the power sockets but can not provide the wired product.

È PREVISTA, A SCELTA, IN UNO DEI DUE LATI CORTI DEI MEETING TABLE RETTANGOLARI. IL RIVESTIMENTO IN PELLE FRAU® SC DELLA "PRESIDENT AREA" PUÒ ESSERE PREVISTO DI COLORE DIFFERENTE DAL RIVESTIMENTO DEL PIANO.

AVAILABLE, BY CHOICE, FOR ONE OF THE TWO SHORT SIDE OF THE RECTANGULAR MEETING TABLES. THE UPHOLSTERY IN PELLE FRAU® SC OF THE "PRESIDENT AREA" CAN BE PROVIDED IN A DIFFERENT COLOR INSTEAD OF THE TOP.

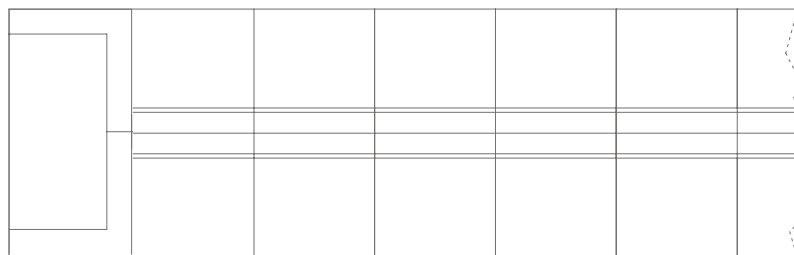
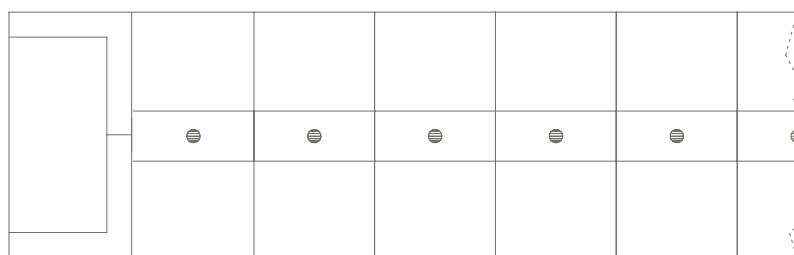
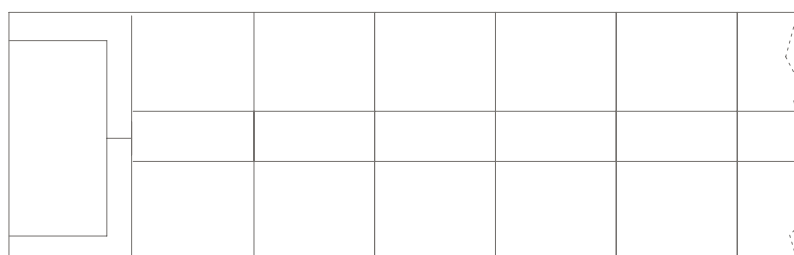

5590635

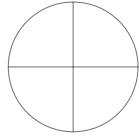

75 / 29 1/2

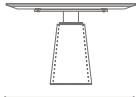

120 / 47 1/4

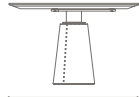

120 / 47 1/4

5590635



75 / 29 1/2

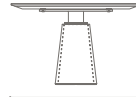

120 / 47 1/4

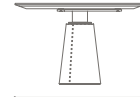

120 / 47 1/4

5590637

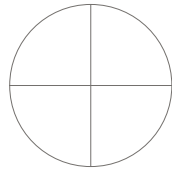

75 / 29 1/2

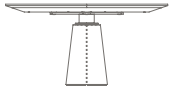

150 / 59"

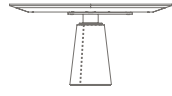

150 / 59"

5590637

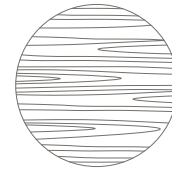

75 / 29 1/2

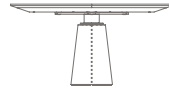

150 / 59"

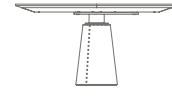

150 / 59"

5590621 Rectangular
5590641 Oval

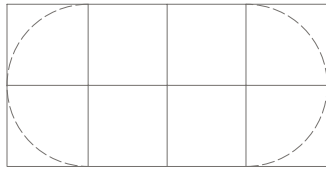

75 / 29 1/2

68 / 26 3/4

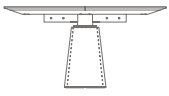

150 / 59"



296 / 116 1/2

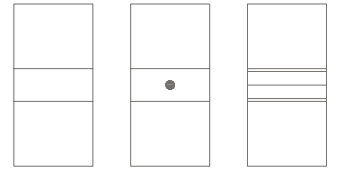

5590622 Rectangular
5590642 Oval

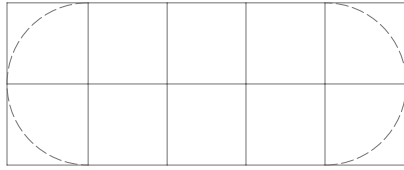

75 / 29 1/2

68 / 26 3/4

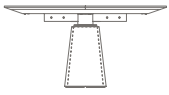

150 / 59"



369 / 145 1/4

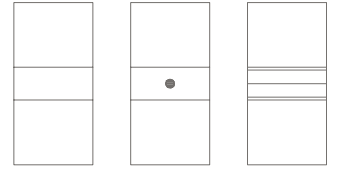

5590623 Rectangular
5590643 Oval

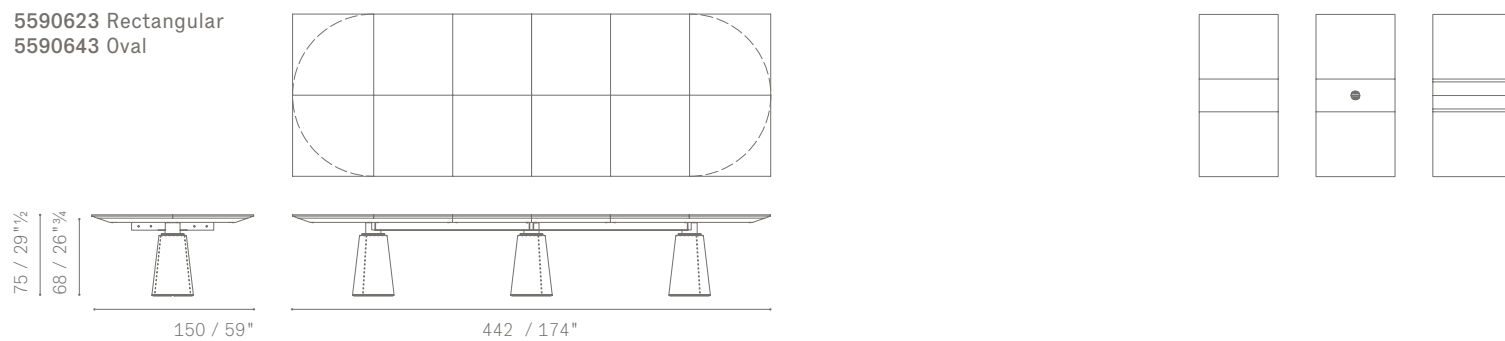

5590624 Rectangular
5590644 Oval

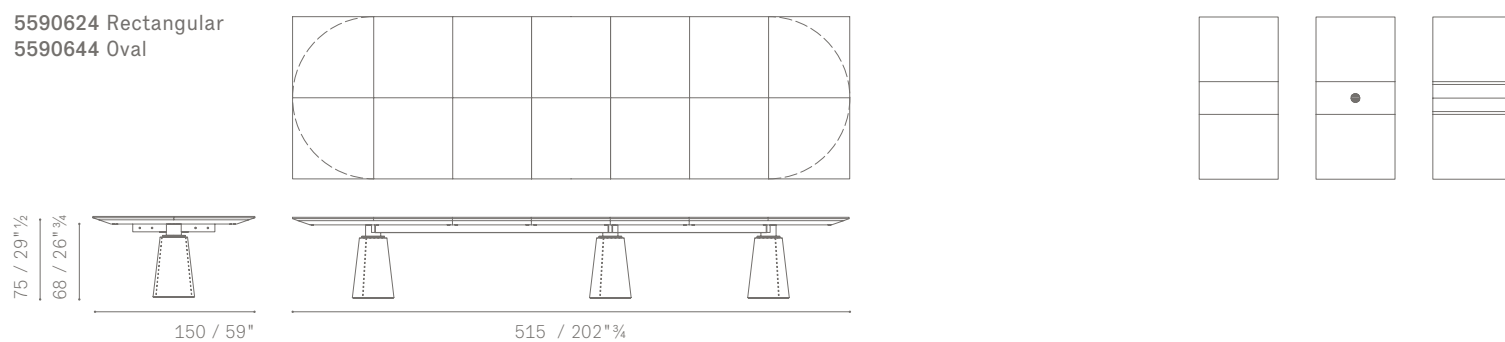

5590625 Rectangular
5590645 Oval

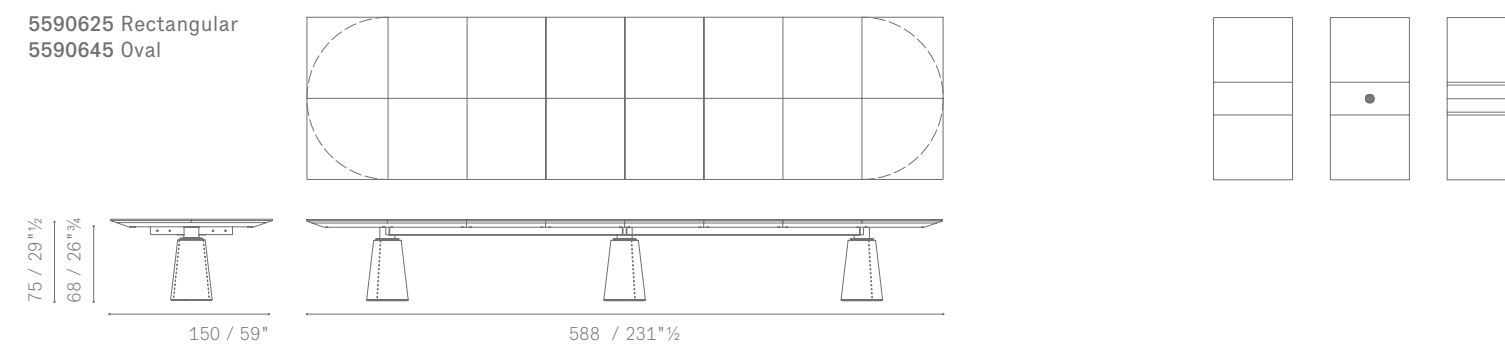

5590626 Rectangular
5590646 Oval

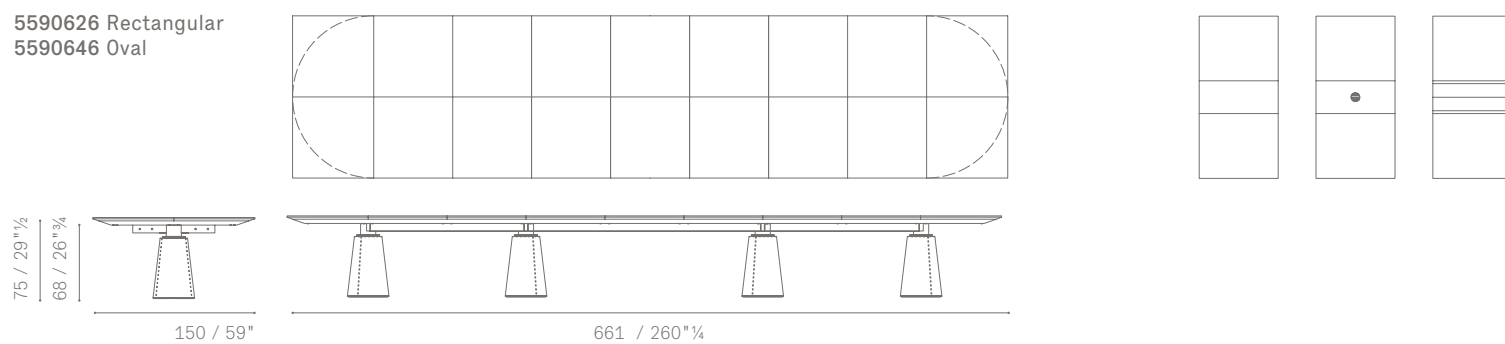

5590627Rectangular
5590647Oval

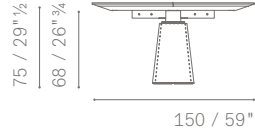
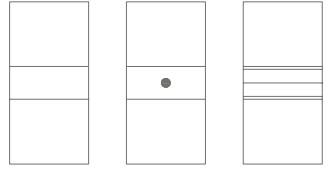
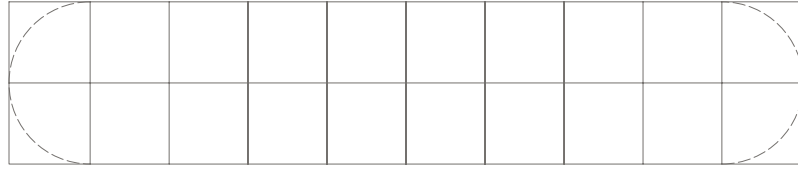

150 / 59"

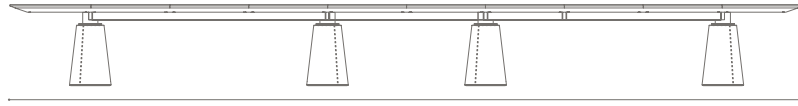

734 / 289"

MESA DUE MEETING TABLES

